

Revision Notes.				
R1 - NOTES UPDATED TO INCLUDE SPARE PART DETAILS.				
APA: T.CHOI	Drawn:R.BATES	Checked:B.CHILDS	Approved:G.PLITH	Date: 07/04/14
R2 - SCREW HOLES UPDATED ON HOUSING AS PER ECR CR-A292.				
APA: Y.ZHANG	Drawn: R.BATES	Checked: A.FEDERIGHI	Approved: G.PLITH	Date: 10/07/14

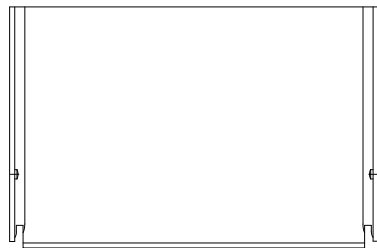

- NOTES:**
1. FINISH: BLACK.
 2. MATERIAL: STEEL 1.5T
 3. WHEN SUPPLIED AS A SPARE PART ITEM TO BE SUPPLIED IN A PRESS SEAL BAG.
 4. WHEN SUPPLIED AS A SPARE PART FOR GIFTBOX LABEL REFER TO LATEST REVISION OF DRAWING BE-001049-XX-10.

PROPRIETARY NOTICE
 THIS DESIGN AND TECHNICAL INFORMATION APPEARING ON THIS DRAWING IS THE PROPERTY OF BRIGADE ELECTRONICS, AND IS DISCLOSED IN CONFIDENCE. IT IS NOT TO BE COPIED, REPRODUCED, REVEALED OR EXPROPRIATED BY OTHERS, EITHER IN WHOLE OR IN PART WITHOUT THE EXPRESS WRITTEN CONSENT OF BRIGADE ELECTRONICS.

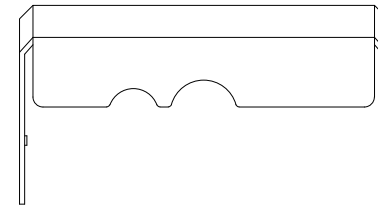
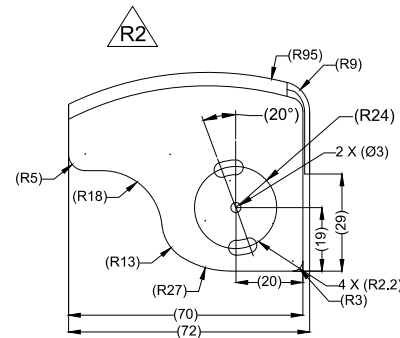
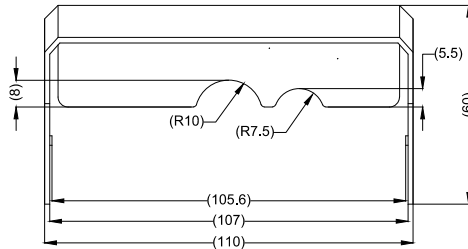
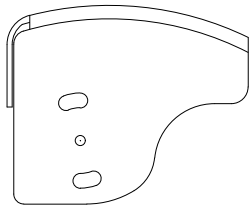
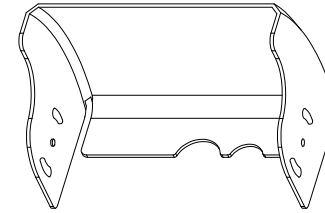
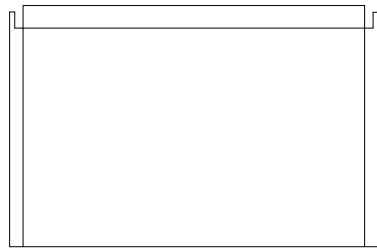

Assembly Pl Approval -	Approved by D.KERAI	Checked by J.NEWMAN	Drawn by M.BUTLER
Angle of Projection 	Units mm	Scale N/A	Released 09/02/11
Status RELEASED	Assembly Ref VBV-71XC SS		
Part No 3657	BE-001431-02-11		